

A4 EN 14439 - C50 - D50

TOWER CONFIGURATION - REACTIONS

CONFIGURAZIONE TORRE - REAZIONI / CONFIGURATION TOUR - RÉACTIONS / TORRE DE CONFIGURACIÓN - REACCIONES / КОНФИГУРАЦИЯ БАШНИ - РЕАКЦИИ

EN 14439 - C50
▣ 1,10 m L3,2 m - A

	H (m)	Z(t)	F1 (kN)
5,9 m	36.03	75.5	619
5,9 m	30.13	50.3	401
5,9 m	24.23	45.2	304
5,9 m	18.33	40.2	273
5,9 m	12.43	40.2	256

▣ 1,10 m L3,2 m - B

	H (m)	Z(t)	F1 (kN)
5,9 m	35.63	70.7	613
5,9 m	29.73	50.5	398
5,9 m	23.83	40.4	299
5,9 m	17.93	40.4	273
5,9 m	12.03	40.4	257

▣ 1,10 m L3,2 m - E

	H (m)	Z(t)	F1 (kN)
5,9 m	35.43	70.7	603
5,9 m	29.53	50.5	390
5,9 m	23.63	40.4	294
5,9 m	17.73	40.4	268
5,9 m	11.83	40.4	252

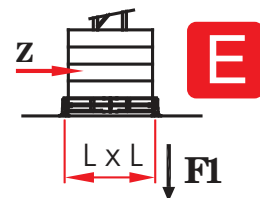
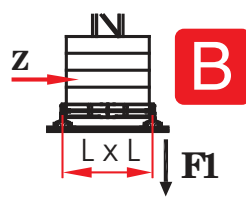
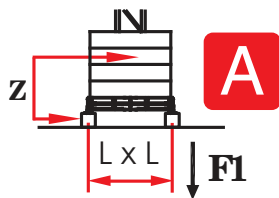
▣ 1,10 m - D

	H (m)	F2 (kN)	F3 (kN)
5,9 m	34.74	1004	911
5,9 m	28.84	650	578
5,9 m	22.94	374	313
5,9 m	17.04	255	173
5,9 m	11.14	254	173

1,10 m TP1,1/1,2 - D

	H (m)	F2 (kN)	F3 (kN)
5,9 m	41,03	1443	1339



Comply with the specified ballast / Attenersi alla zavorra indicata / S'en tenir au lest indiqué / Spagnolo / Соблюдать указанный балласт

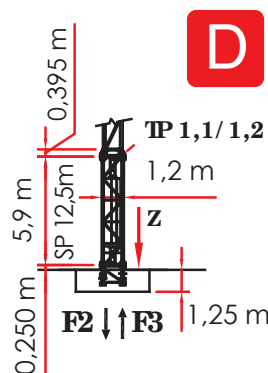
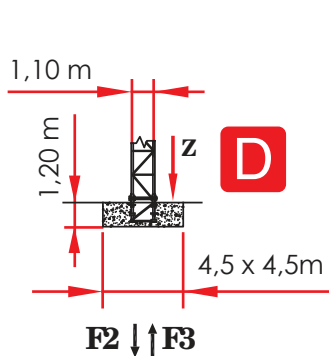

TOWER CONFIGURATION - REACTIONS

CONFIGURAZIONE TORRE - REAZIONI / CONFIGURATION TOUR - RÉACTIONS / TORRE DE CONFIGURACIÓN - REACCIONES / КОНФИГУРАЦИЯ БАШНИ - РЕАКЦИИ

EN 14439 - D50

1,10 m L3,2 m - A

	H (m)	Z(t)	F1 (kN)
5,9 m	32.49	80.6	685
5,9 m	30.13	70.5	579
5,9 m	24.23	50.3	351
5,9 m	18.33	45.2	281
5,9 m	12.43	40.2	256

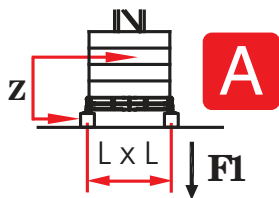

1,10 m L3,2 m - B

	H (m)	Z(t)	F1 (kN)
2.36 m	32.09	80.8	689
5,9 m	29.73	70.7	581
5,9 m	23.83	45.5	344
5,9 m	17.93	40.4	273
5,9 m	12.03	40.4	257

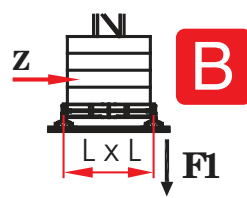

1,10 m L3,2 m - E

	H (m)	Z(t)	F1 (kN)
2.36 m	31.89	80.8	677
5,9 m	29.53	70.7	569
5,9 m	23.63	45.5	336
5,9 m	17.73	40.4	268
5,9 m	11.83	40.4	252

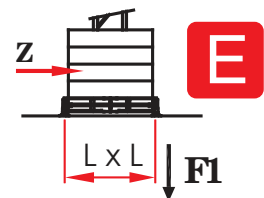

1,10 m - D

	H (m)	F2 (kN)	F3 (kN)
2.36 m	31.20	1069	979
5,9 m	28.84	903	823
5,9 m	22.94	537	475
5,9 m	17.04	264	203
5,9 m	11.14	254	173

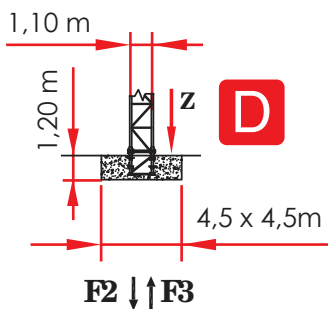

1,10 m TP1,1/1,2 - D

	H (m)	F2 (kN)	F3 (kN)
5,9 m	35.13	1375	1284

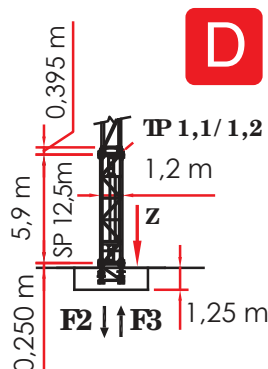

Comply with the specified ballast / Attenersi alla zavorra indicata / S'en tenir au lest indiqué / Spagnolo / Соблюдать указанный балласт

LOAD DIAGRAMS _2.5 T_3.0 T

DIAGRAMMA DI PORTATA / DIAGRAMME DE CHARGE UTILE / CURVAS DE CARGA /

ДИАГРАММА ГРУЗОПОДЪЕМНОСТИ

2.500 Kg						3.000 Kg					
JIB	18.0	24.0	30.0	36.0	42.0	JIB	18.0	24.0	30.0	36.0	42.0
1,4 ▶	18,0	24,0	26,0	24,0	24,5	1,4 ▶	18,0	23,0	22,0	21,0	20,0
6	2500	2500	2500	2500	2500	6	3000	3000	3000	3000	3000
8	2500	2500	2500	2500	2500	8	3000	3000	3000	3000	3000
10	2500	2500	2500	2500	2500	10	3000	3000	3000	3000	3000
12	2500	2500	2500	2500	2500	12	3000	3000	3000	3000	3000
14	2500	2500	2500	2500	2500	14	3000	3000	3000	3000	3000
16	2500	2500	2500	2500	2500	16	3000	3000	3000	3000	3000
18	2500	2500	2500	2500	2500	18	3000	3000	3000	3000	3000
20		2500	2500	2500	2500	20		3000	3000	3000	3000
22		2500	2500	2500	2500	22		3000	3000	2911	2790
24		2500	2500	2500	2500	24		2805	2731	2651	2541
26			2500	2431	2330	26			2504	2431	2330
28			2312	2244	2149	28			2312	2244	2149
30			2145	2081	1993	30			2145	2081	1993
32				1940	1857	32				1940	1858
34				1815	1738	34				1815	1738
36				1705	1631	36				1705	1631
38					1536	38					1536
40					1452	40					1452
42					1375	42					1375

ULTRALIFT _ALL INTERMEDIATE LOADS ARE DECREASED OF 10% IF THE CRANE IS NOT EQUIPPED WITH ULTRALIFT CONTROL / SENZA IL SISTEMA ULTRALIFT TUTTE LE PORTATE INTERMEDIE DIMINUISCONO IL CARICO DEL 10% / LES CHARGES INTERMEDIARES SONT DIMINUEES DE 10% SI LA GRUE N'EST PAS EQUIPE D'UN CONTROLE ULTRALIFT / SIN EL SISTEMA ULTRALIFT LOS MISURA INTERMEDIOS DISMINUIR EL CARICO DEL 10% / БЕЗ ULTRALIFT ПРОМЕЖУТОЧНОЙ УМЕНЬШАЕТСЯ НА 10% НАГРУЗКИ.

HOISTING WINCH INVERTER - PERFORMANCES

MECCANISMI / MÉCANISMES / MECANISMOS / МЕХАНИЗМЫ

400 VOLT ± 5% - 50Hz _DIRECTIVE 14/12 - 2005/88/CE

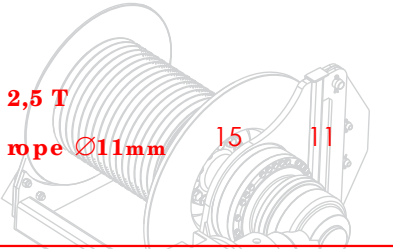
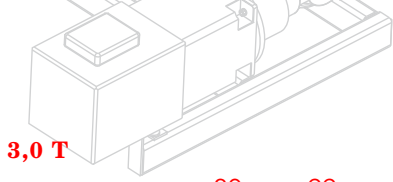
HOISTING WINCH	POWER POTENZA	ROPE FUNE	STEP MARCIA	LOAD CARICO	SPEED VELOCITÀ	LOAD CARICO	SPEED VELOCITÀ
ARGANO	CV-ch Ps-hp	kW	m.	Kg.	m/min.	Kg.	m/min.
 <p>2,5 T rope Ø11mm</p>	15	11	80	1	2500	4,4	
				2	2500	22	
				3	1250	44	
				4 (*)	200	48	
				1	3000	7,6	
 <p>3,0 T rope Ø11mm</p>	30	22	240	2	3000	23	
				3	3000	38	
				4	1500	61	
				5	1000	76	
				5 (*)	400	91	

ABSORPTIONS / ASSORBIMENTI

14 kW

22.5 kW



SLEWING

0,37 / 0,7 / 1,0 min⁻¹

4,0 kW

(*) SPEED AUTOMATICALLY CONTROLLED BY A CURRENT SENSOR / VELOCITÀ REGOLATA AUTOMATICAMENTE DA SENSORE DI CORRENTE / VITESSE RÉGLÉE AUTOMATIQUÉMENT PAR CAPTEUR DE COURANT / ACELERAR CONTROLADO AUTOMÁTICAMENTE POR UN SENSOR DE CORRIENTE / СКОРОСТЬ АВТОМАТИЧЕСКИ РЕГУЛИРУЕТСЯ ДАТЧИКОМ ТОКА

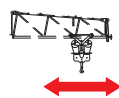

TROLLEY

18,0 / 40,0 / 60,0 m/min

2,2 kW

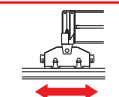























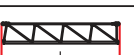

TRAVELLING

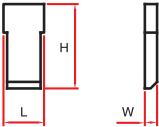
14 m/min

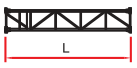
2 X 2,9 kW

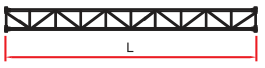



PACKING LIST

LISTA DEI COLLI / LISTE DE COLISAGE / LISTA DE CONTENIDO / ВЕС И ГАБАРИТНЫЕ РАЗМЕРЫ

DENOMINAZIONE DESCRIPTION	POS. ITEM	PEZZI PIECES	DRAWING DISEGNO	DIMENSIONS mm			WEIGHT Kg		
				L	W	H	UNIT	TOTAL	
JIB ELEMENT / ELEMENTO DI FRECCIA ELÈMENT DE FLÈCHE / ELEMENTO DE FLECHA / элемент стрелка	1	n. 1			8,110	1,100	1,700	891	-
		n. 2			6,040	0,900	1,640	450	-
		n. 3			6,040	0,900	1,640	441	-
		n. 4			6,040	0,900	1,640	374	-
		n. 5			5,990	0,900	1,620	351	-
		n. 6			5,970	0,900	1,070	353	-
		n. 7			5,970	0,900	1,030	228	-
COUNTERJIB-TOURNABLE, HOISTING WINCH, ELECTRICAL BOX, / CONTROFRECCIA-GIREVOLE, ARGANO, QUADRO ELETR. / CONTREFLÈCHE TOURNANTE, TREUIL DE LEVAGE, ARMOIRE ELECTRIQUE, / CONTRAFLECHA GIRATORIA, CABRESTANTE ELEVACIÓN, CUADRO ELÉCTRICO, / поворот, контрстрела, подъем, лебедка, электроцит.	2	1			11,970	1,630	2,100	4500	-
COUNTERWEIGHT BLOCKS / BLOCCHI DI CONTRAPPESO / CONTRE-POIDS / BLOQUES DECONTRAPESO / блоки противовеса.	3	2		A45+3	0,870	0,470	2,500	1704	3408
		2		B45+3	0,870	0,335	2,500	1240	2480
		2		C45+3	0,870	0,290	2,500	1082	2164
TOWER ELEMENT / ELEMENTO DI TORRE / ELÈMENT DE MATURE / ELEMENTO DE TORRE / башенный элемент	4	1			2,360	1,100	1,100	595	-
		1			5,900	1,100	1,100	1280	-
		1			11,800	1,100	1,100	2400	-
EXPENDABLE FOUNDATION ELEMENT / TRONCHETTO DI FONDAZIONE / ELÈMENT A SCELLER / TRONCO DE FUNDAÇÃO / СТВОЛ ОСНОВАНИЯ	5	1			1,290	1,320	1,320	520	-

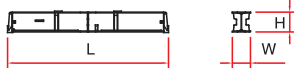
PACKING LIST

LISTA DEI COLLI / LISTE DE COLISAGE / LISTA DE CONTENIDO / ВЕС И ГАБАРИТНЫЕ РАЗМЕРЫ

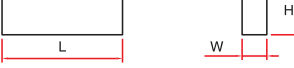
DENOMINAZIONE DESCRIPTION	POS. ПЕМ	PEZZI PIECES	DRAWING DISEGNO	DIMENSIONS mm			WEIGHT Kg		
				L	W	H	UNIT	TOTAL	
BASE MAIN BEAM / TRAVE PRINCIPALE CROCIERA DI BASE / POUTRE DE CHASSIS DE BASE / VIGA PRINCIPAL DE LA CRUCETA DE BASE / главная балка крестовины основания	5	1		4,870	0,670	0,500	1024	-	
HALF BASE BEAM / SEMITRAVE DI BASE / SEMIPOUTRE DE CHASSIS DE BASE / MEDIA VIGA DE LA CRUCETA DE BASE / полюбалка крестовины основания	6	1		2,350	0,450	0,540	450	900	
CONCRETE PAD / BLOCCO DI APPOGGIO / SABOT EN BÉTON / BLOQUE DE APOYO / опорный блок	7	4		3,000	0,600	0,600	2465	9860	
DRIVING BOGIE / BILANCINO TRASL. FOLLE / BOGGIE FOU / BALANCÍN DE TRASLACIÓN LOCO / не приводной баланси р для горизонтального перемещения	8	2		0,800	0,195	0,385	190	380	
DRIVEN BOGIE / BILANCINO TRASLAZIONE MOTORIZZATO / BOGGIE MOTORISÉE / BALANCÍN DE TRASLACIÓN MOTORIZADO / приводной баланси р для горизонтального перемещения	9	2		0,925	0,425	0,385	310	620	
BASE BALLAST BLOCK / BLOCCO DI ZAVORRA / LEST DE BASE / BLOQUE DE LASTRE / блок балласта	10	1		C	3,000	1,200	0,610	5050	-
				C1	3,000	1,200	0,305	2525	-

EXTERNAL CLIMBING

SOPRALZO IDRAULICO / TELESOPABLE / ELEVACIÓN HIDRÁULICA / ГИДРАВЛИЧЕСКОЕ НАРАЩИВАНИЕ

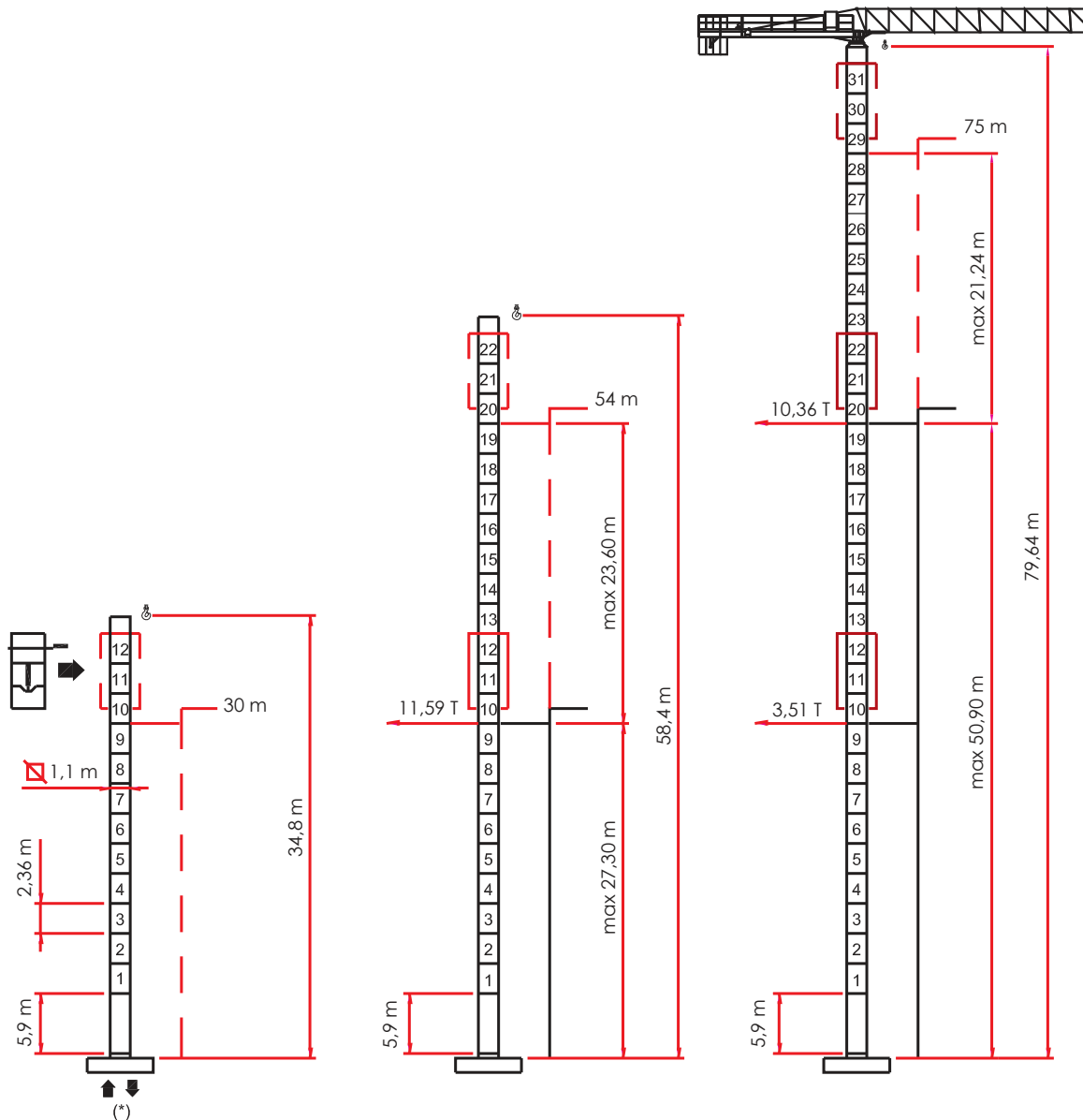

[MRT 48 _REV. _0413] ADL / TECHNICAL DEPARTEMENT

THE DATA OBJECT OF THESE SHEETS ARE SUBJECT TO CHANGE WITHOUT PRIOR NOTICE / I DATI OGGETTO DELLE PRESENTI SCHEDE POTREBBERO SUBIRE MODIFICHE SENZA PREAVVISO / LES INFORMATIONS DONNÉES DANS LES PRÉSENTES FICHES POURRAIENT SUBIR DES MODIFICATIONS SANS PRÉAVIS / LOS DATOS CONTENIDOS EN ESTE FORMULARIO ESTÁN SUJETAS A CAMBIOS SIN PREVIO AVISO / ДАННЫЕ, УКАЗАННЫЕ В НАСТОЯЩИХ СПЕЦИФИКАЦИЯХ, МОГУТ ИЗМЕНЯТЬСЯ БЕЗ ПРЕДВАРИТЕЛЬНОГО ПРЕДУПРЕЖДЕНИЯ.